

# ENVIROFLEX® - SIDE SLOPE LINED CHANNEL

TAPERED, VERTICALLY INTERLOCKING ARTICULATING CONCRETE BLOCK (ACB) SYSTEM

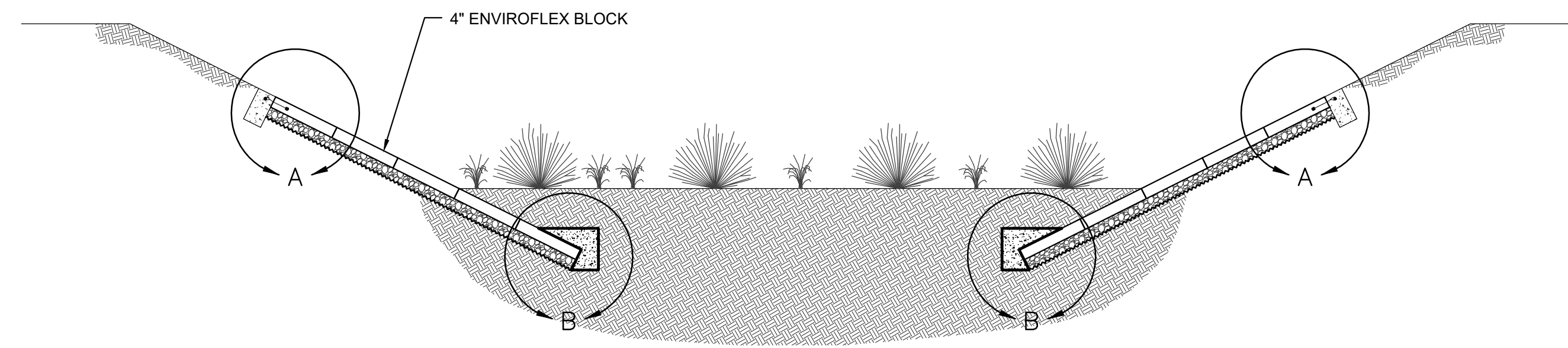

TYPICAL ENVIROFLEX® LINED SIDE SLOPE CHANNEL SECTION

N.T.S.

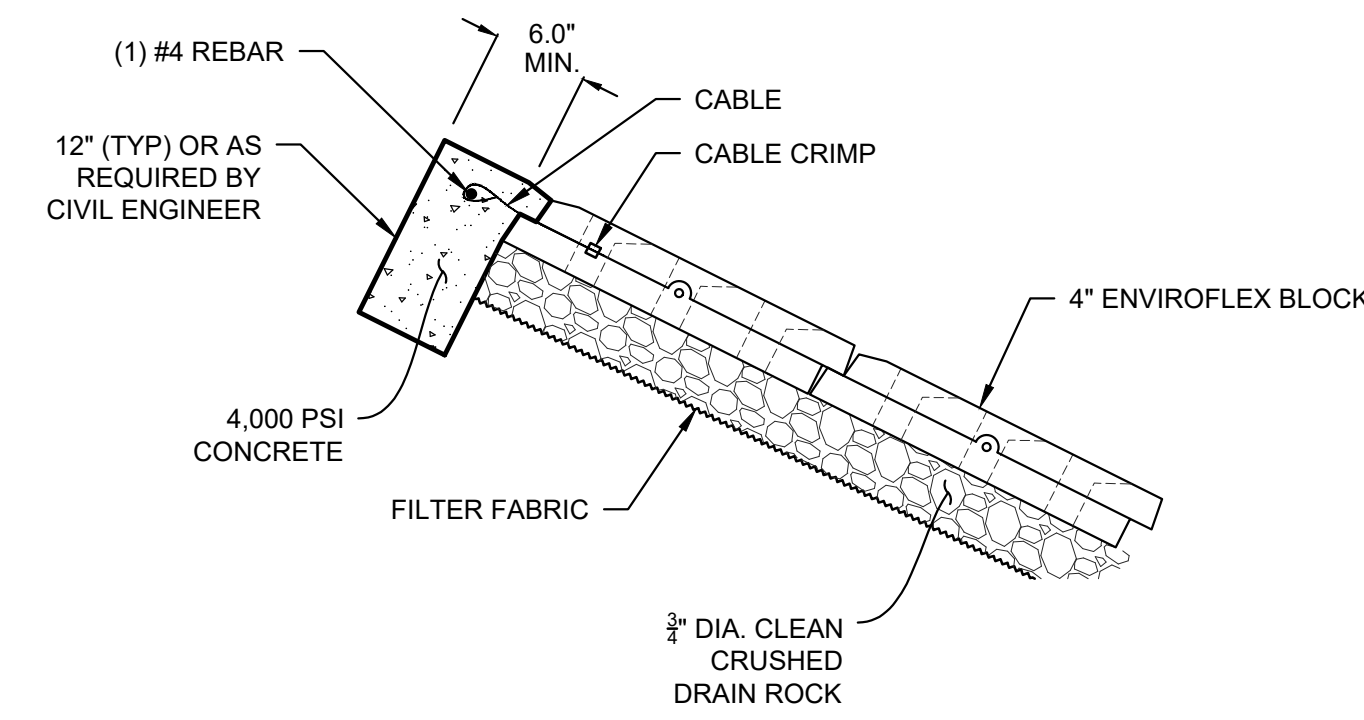

DETAIL A - CONTAINMENT EDGE

N.T.S.

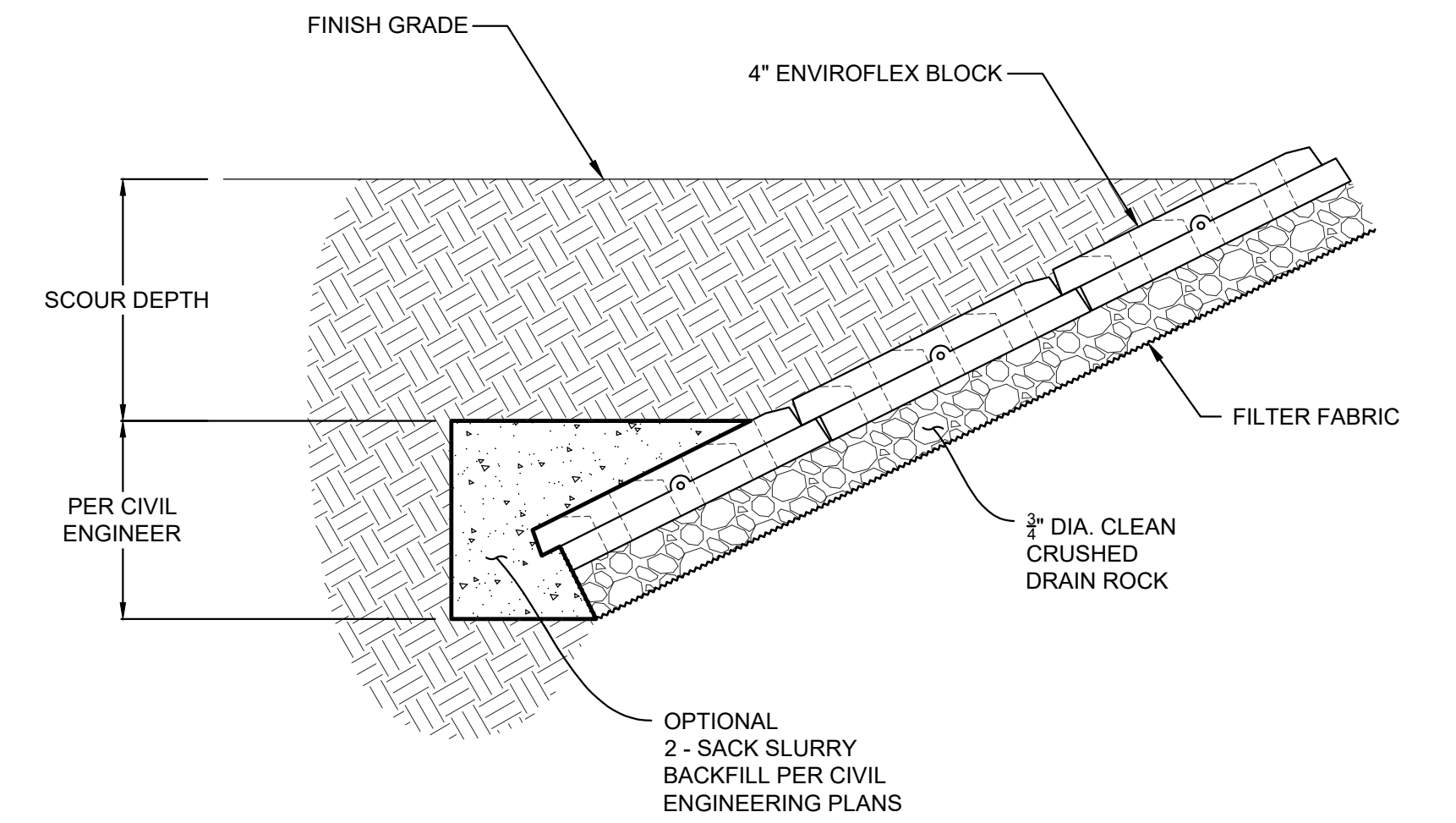

DETAIL B - TOE DOWN

N.T.S.

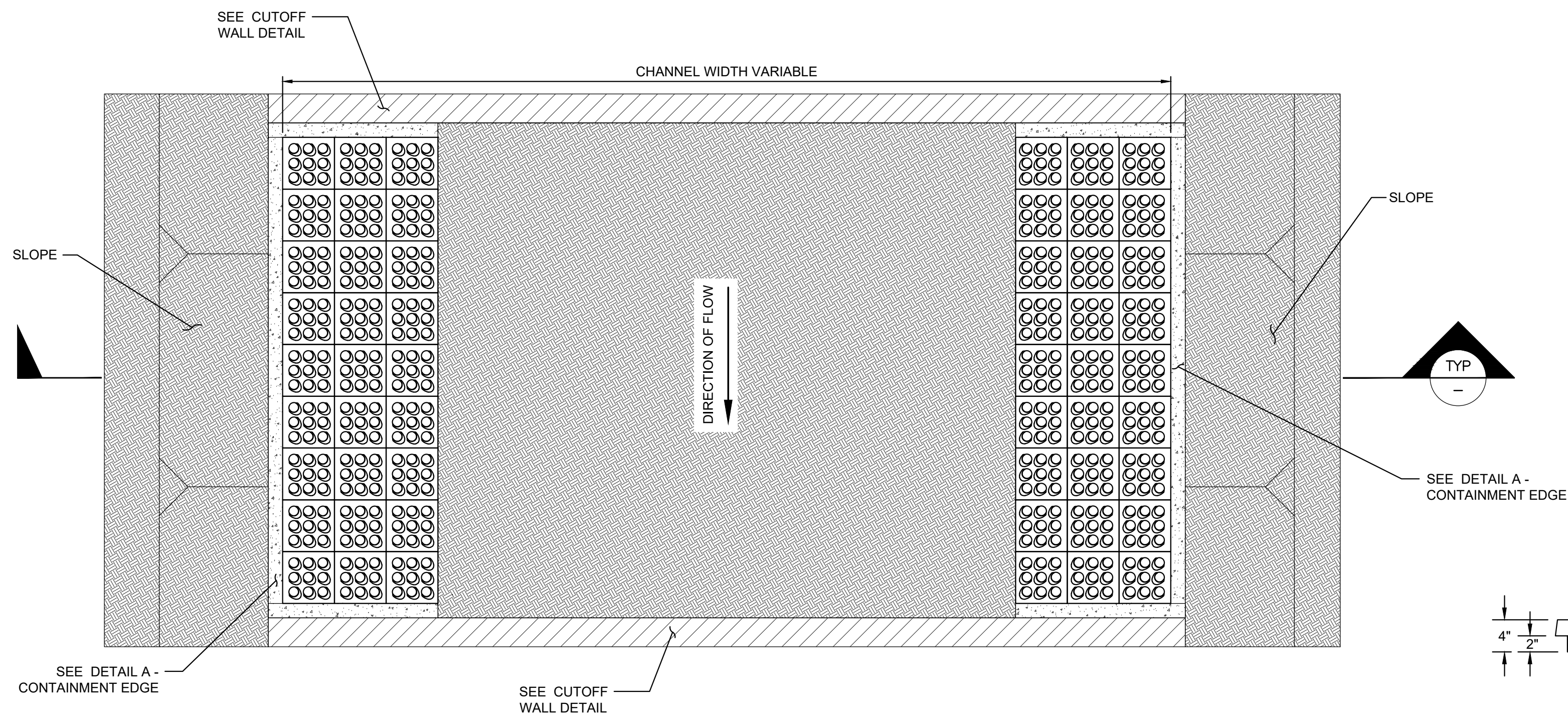

TYPICAL ENVIROFLEX® SIDE SLOPE LINED CHANNEL

N.T.S.

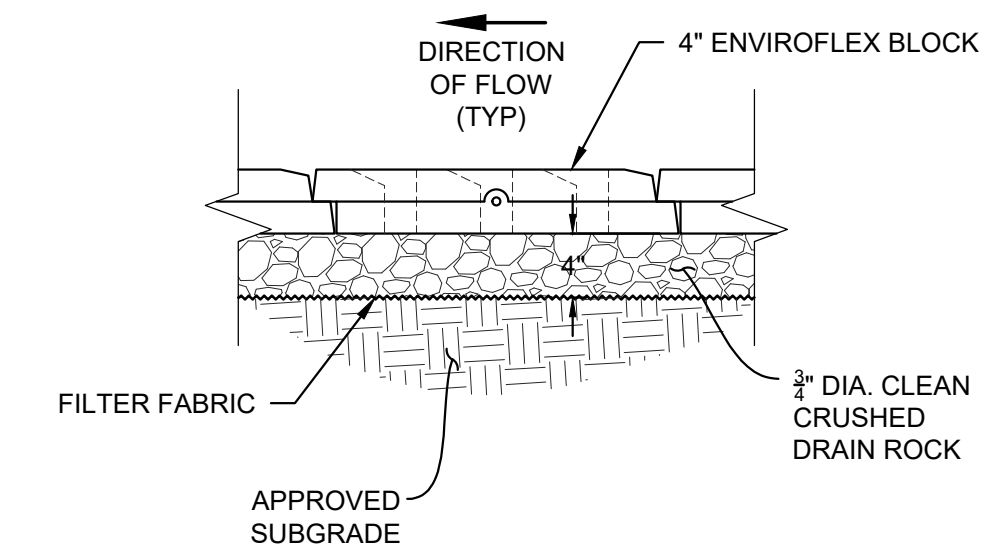

TYPICAL SECTION  
(W/ 4" DRAINAGE LAYER)

N.T.S.

| 4" ENVIROFLEX DESIGN CRITERIA |        |      |
|-------------------------------|--------|------|
| W/ 4" DRAINAGE LAYER          |        |      |
| CRITICAL SHEAR STRESS         | PSF    | 18   |
| VELOCITY LIMIT                | FT/SEC | 23.3 |

NO CONNECTORS OR CABLES WERE USED IN THE TESTING FOR THE VALUES LISTED ABOVE.

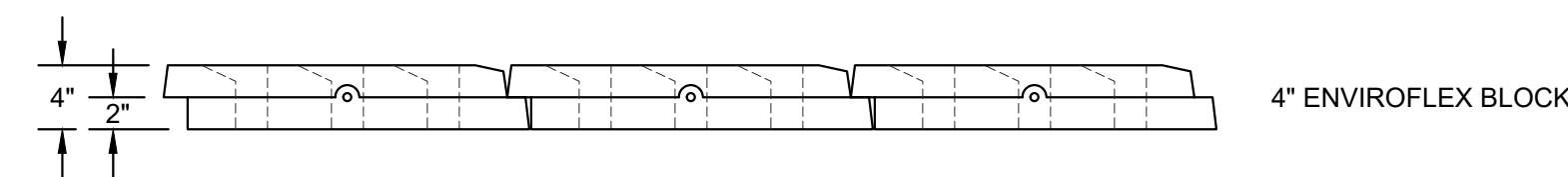

4" ENVIROFLEX BLOCK

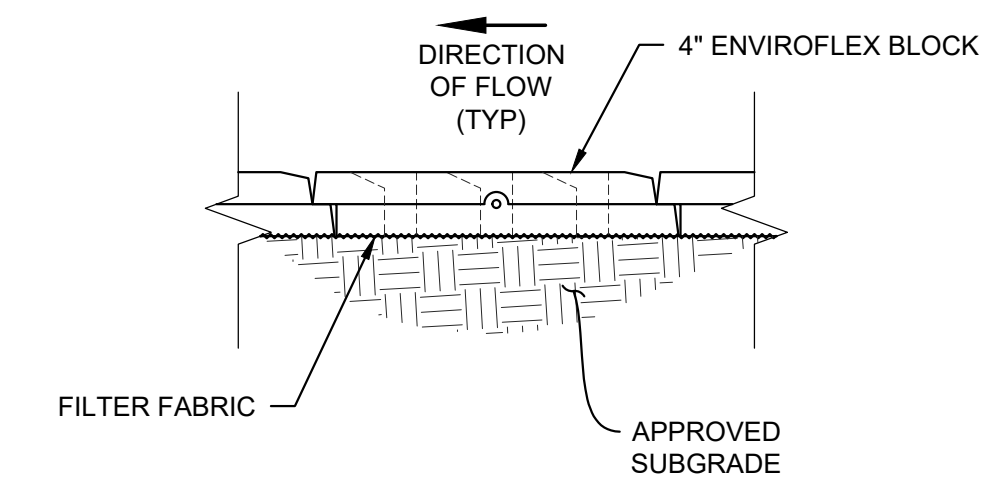

TYPICAL SECTION  
(OPTIONAL - W/ NO DRAINAGE LAYER)

N.T.S.

| 4" ENVIROFLEX DESIGN CRITERIA |        |      |
|-------------------------------|--------|------|
| W/ NO DRAINAGE LAYER          |        |      |
| CRITICAL SHEAR STRESS         | PSF    | 6.2  |
| VELOCITY LIMIT                | FT/SEC | 12.1 |

NO CONNECTORS OR CABLES WERE USED IN THE TESTING FOR THE VALUES LISTED ABOVE.

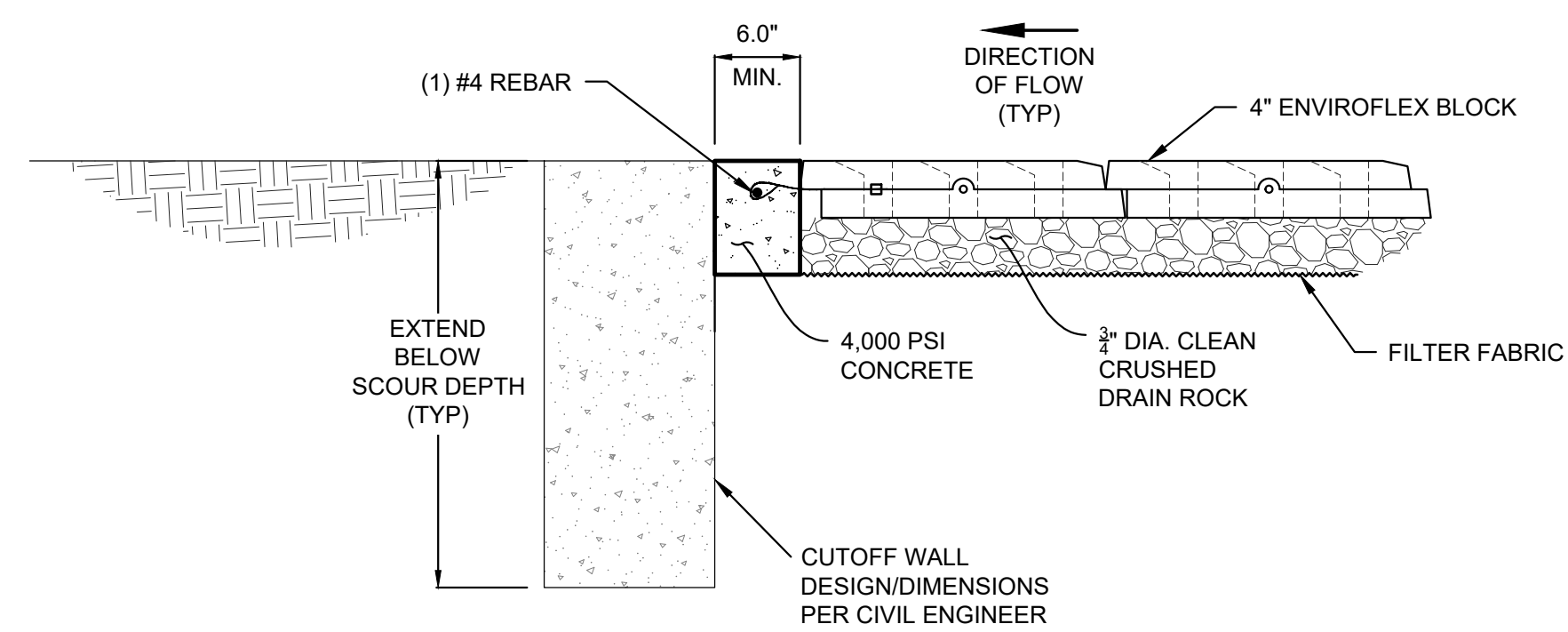

CUTOFF WALL DETAIL

N.T.S.

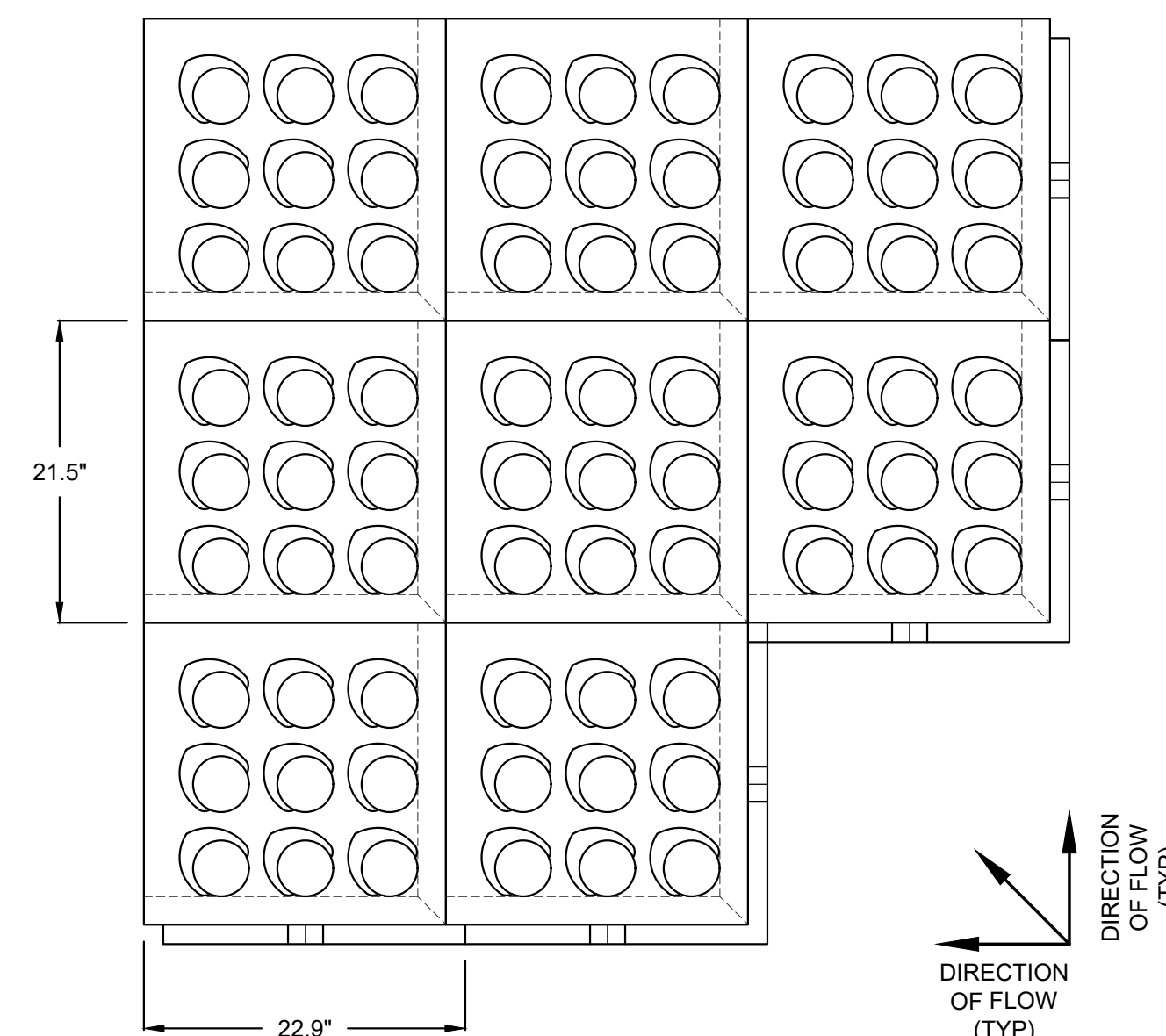

ENVIROFLEX® BLOCK DETAILS



1265 CARLSBAD VILLAGE DRIVE, SUITE 100, CARLSBAD, CA 92008  
(800) 346-7995 WWW.SOILRETENTION.COM