

IRRIGATION DETAILS

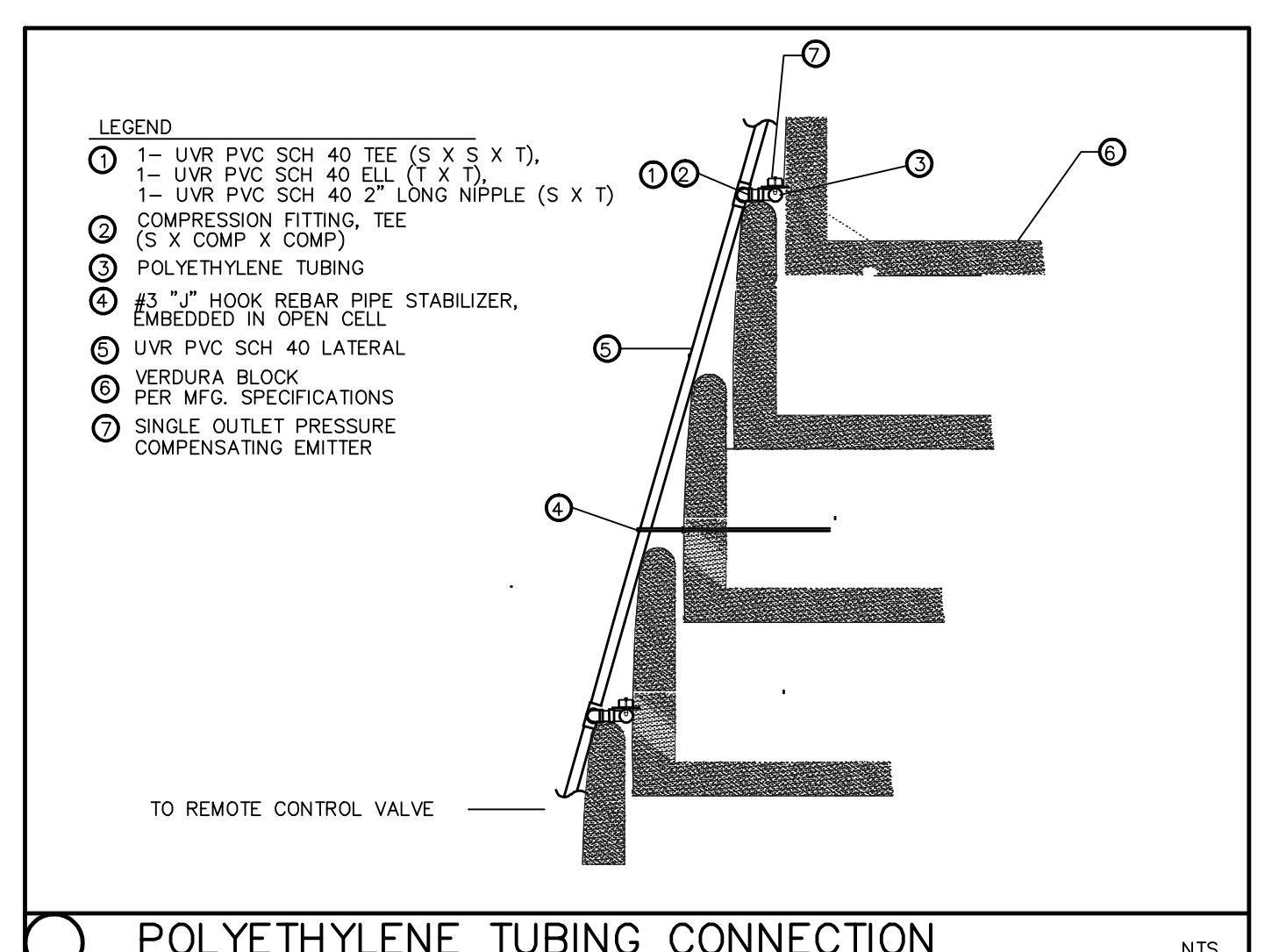
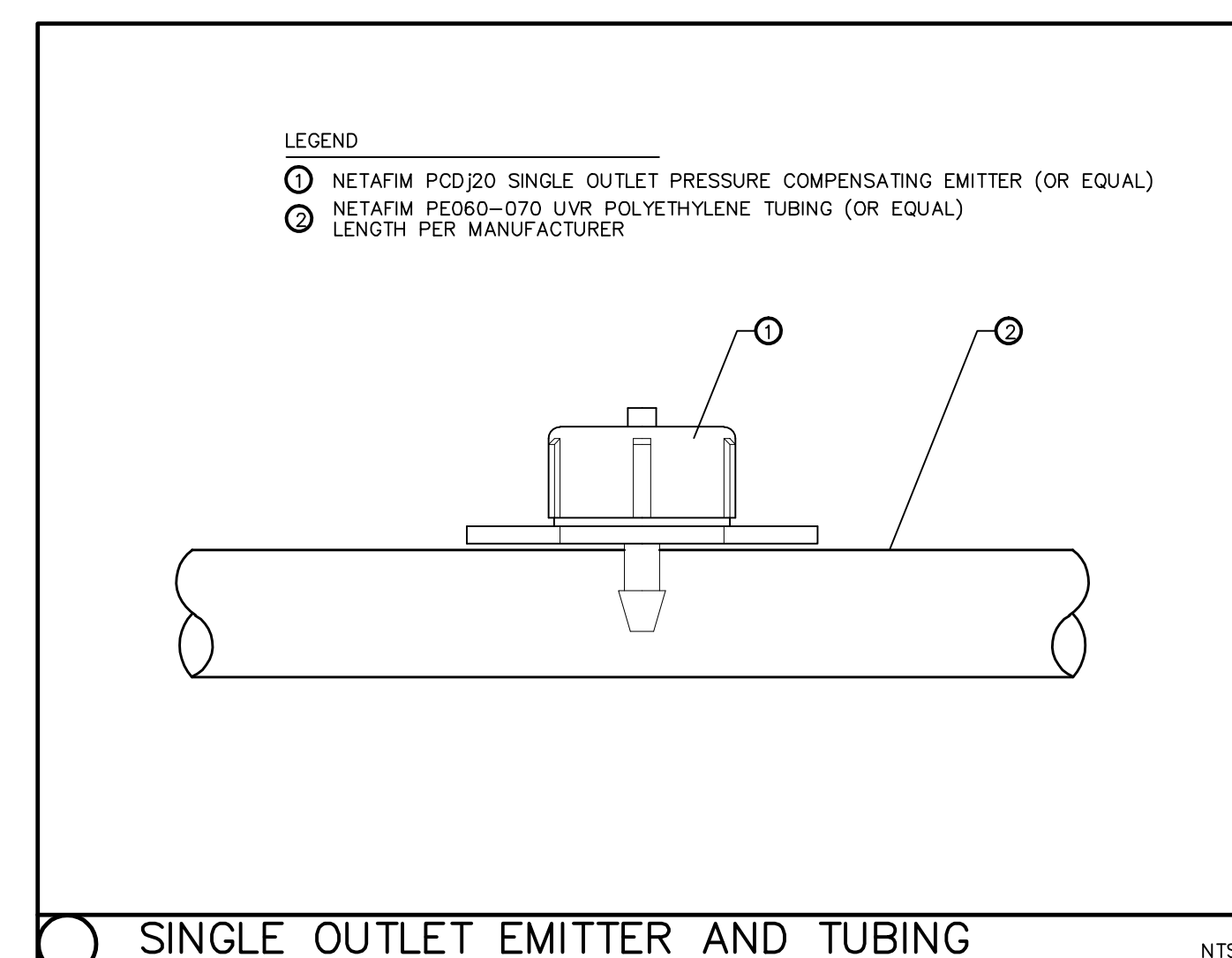
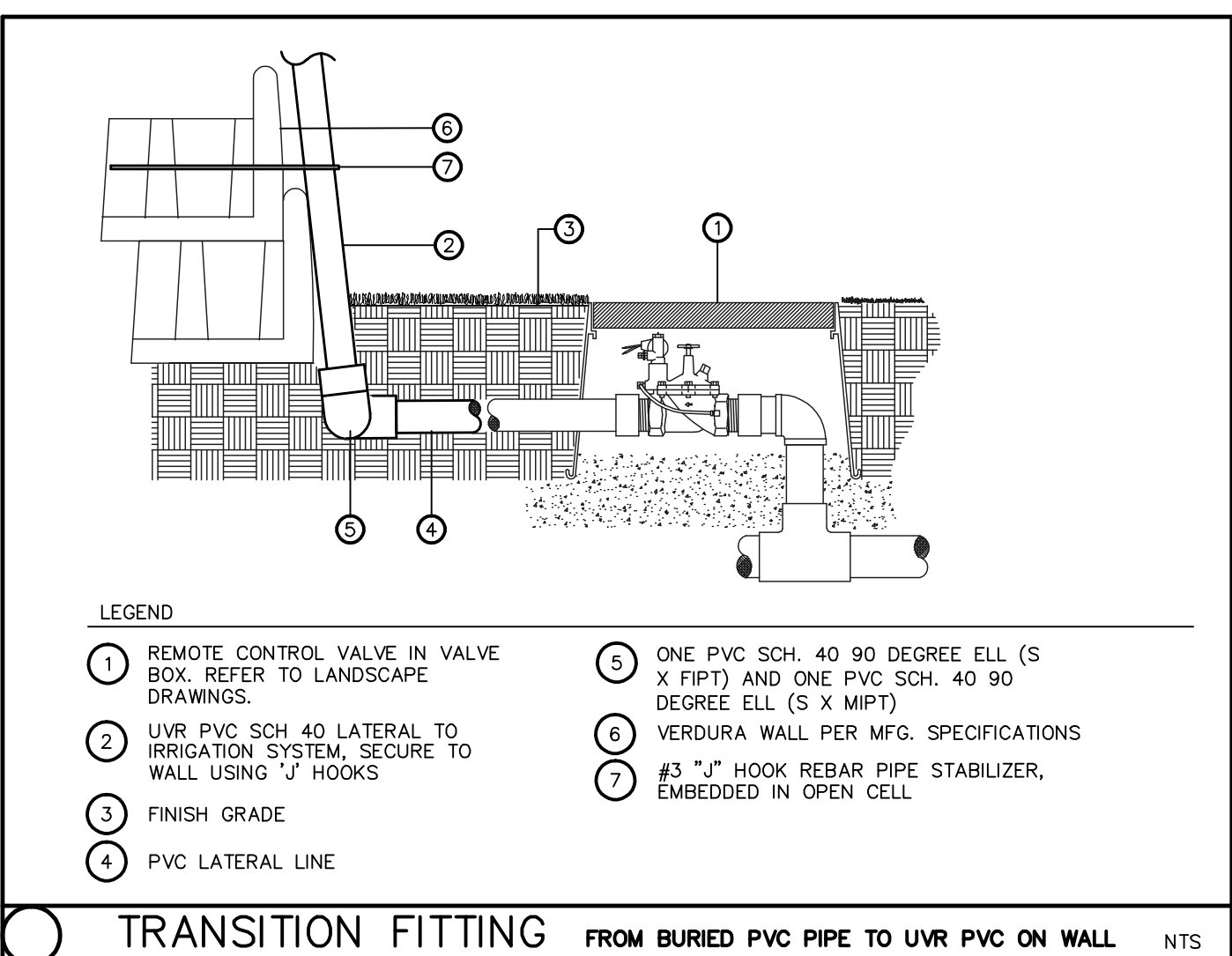
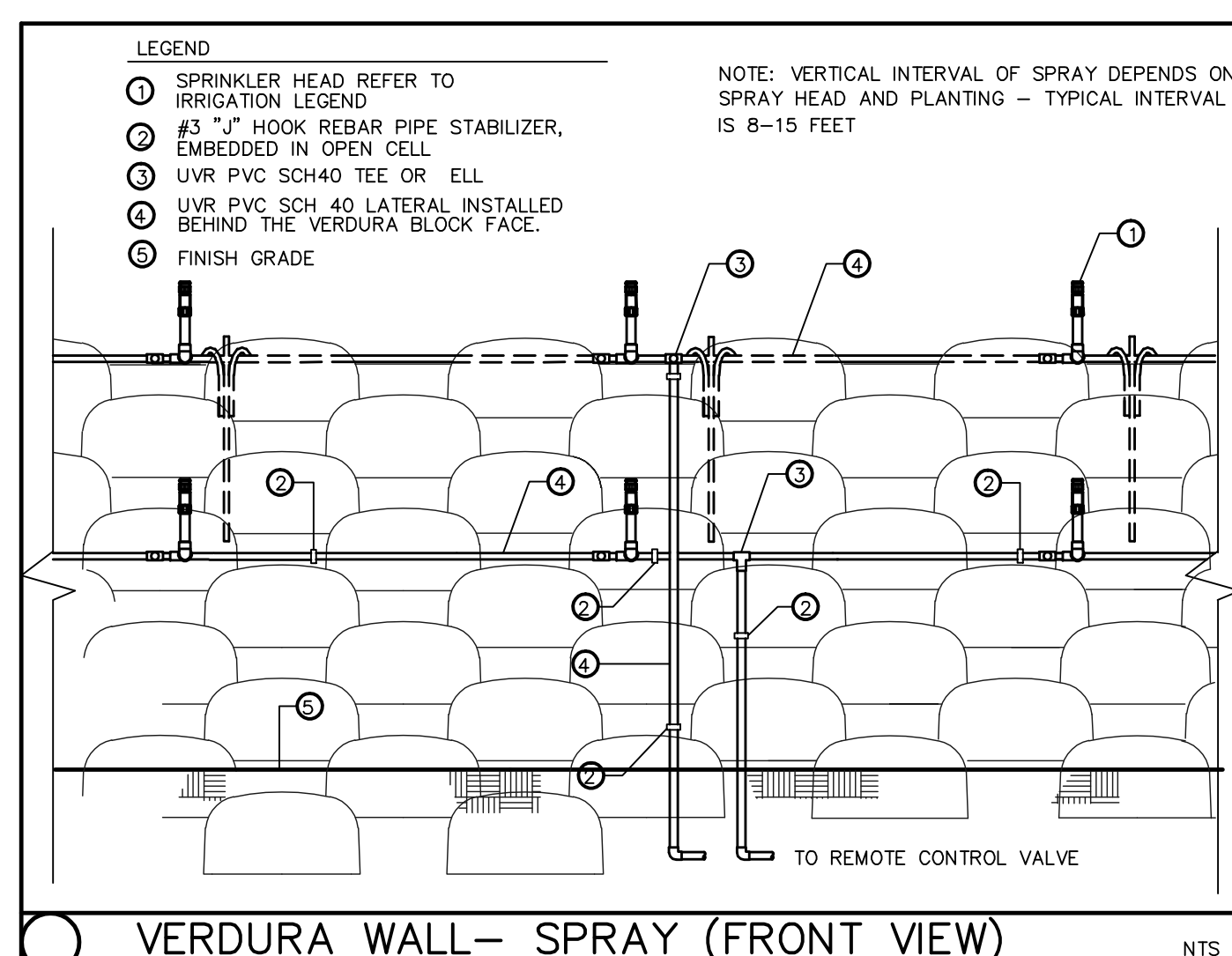
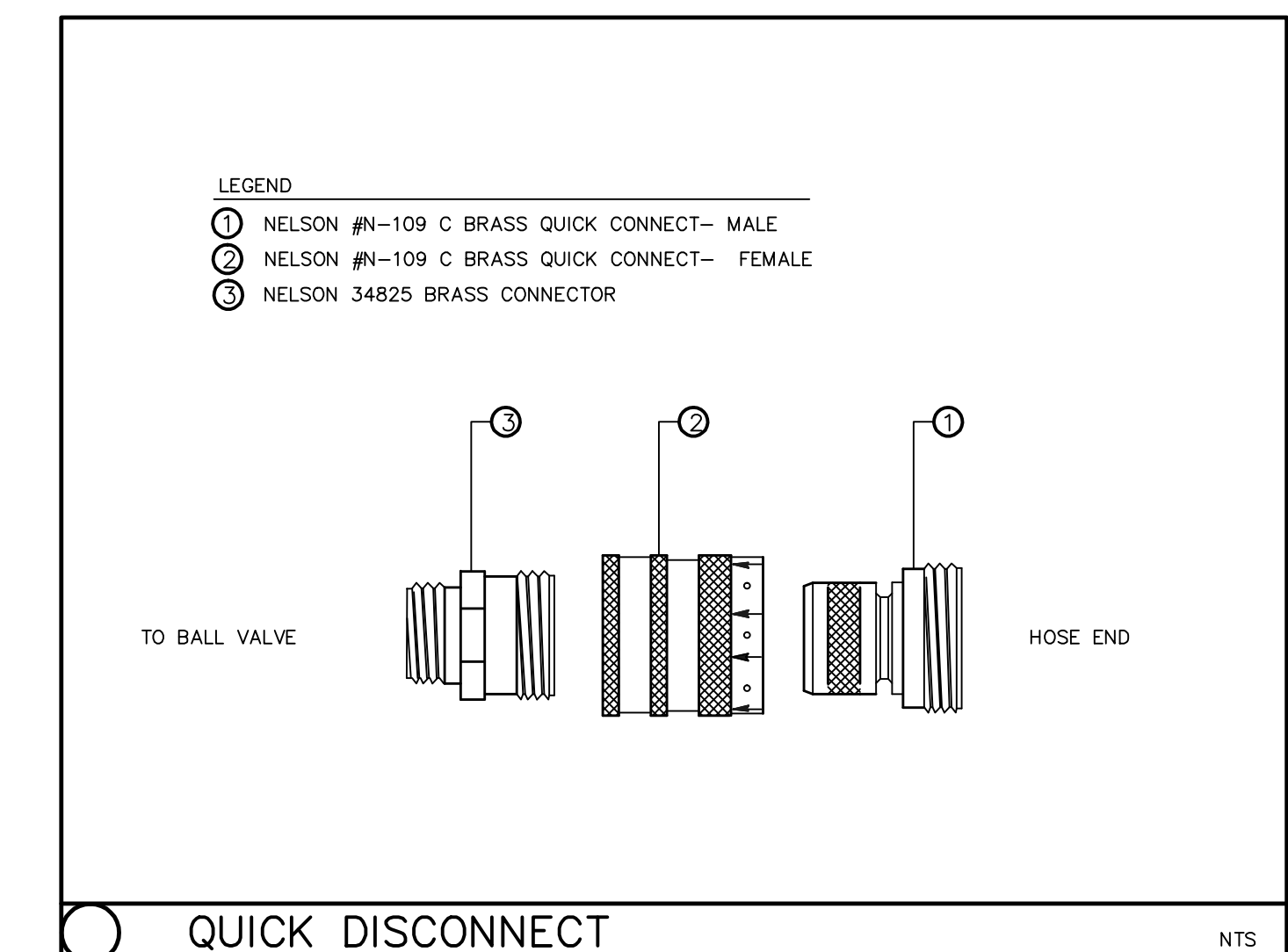
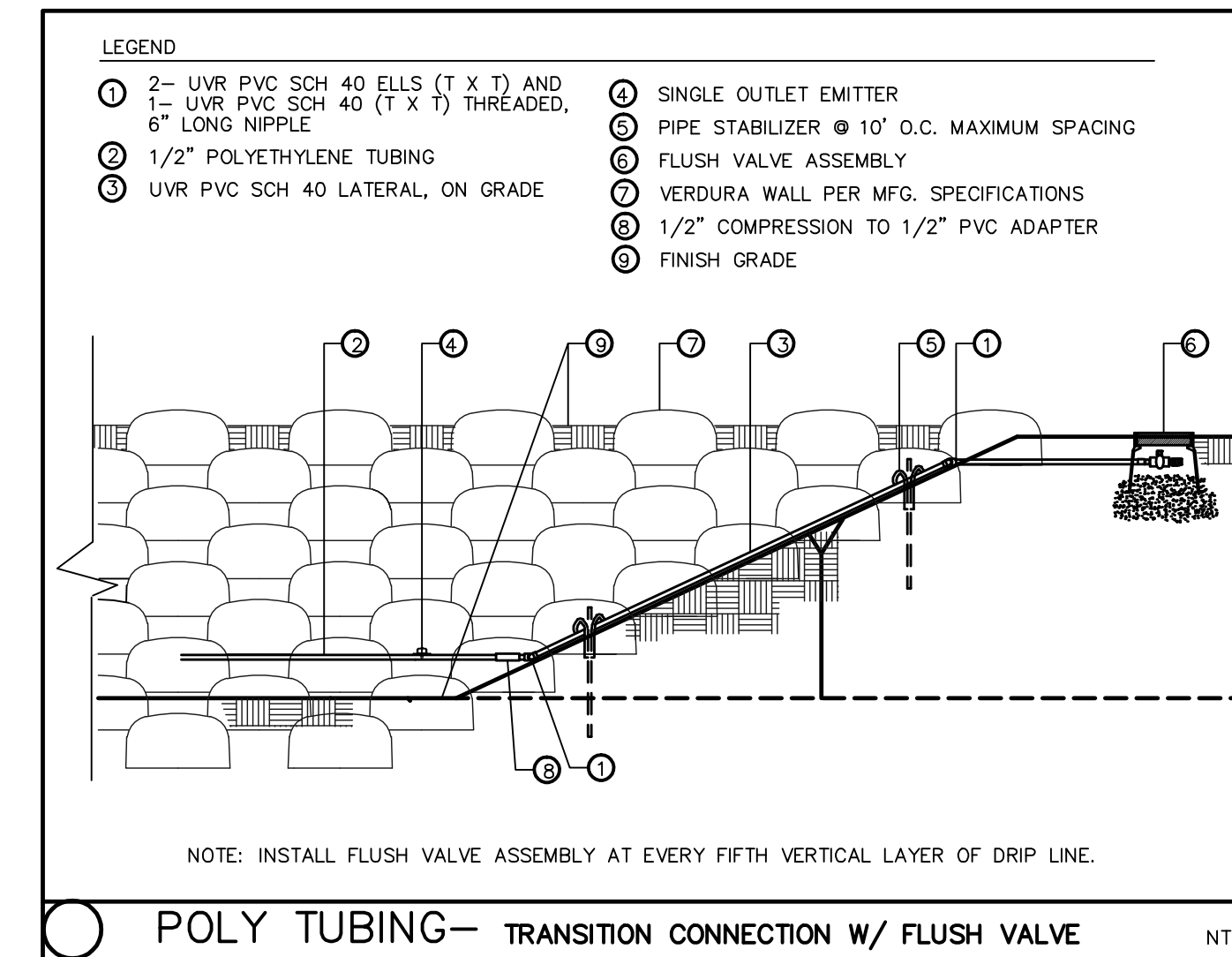
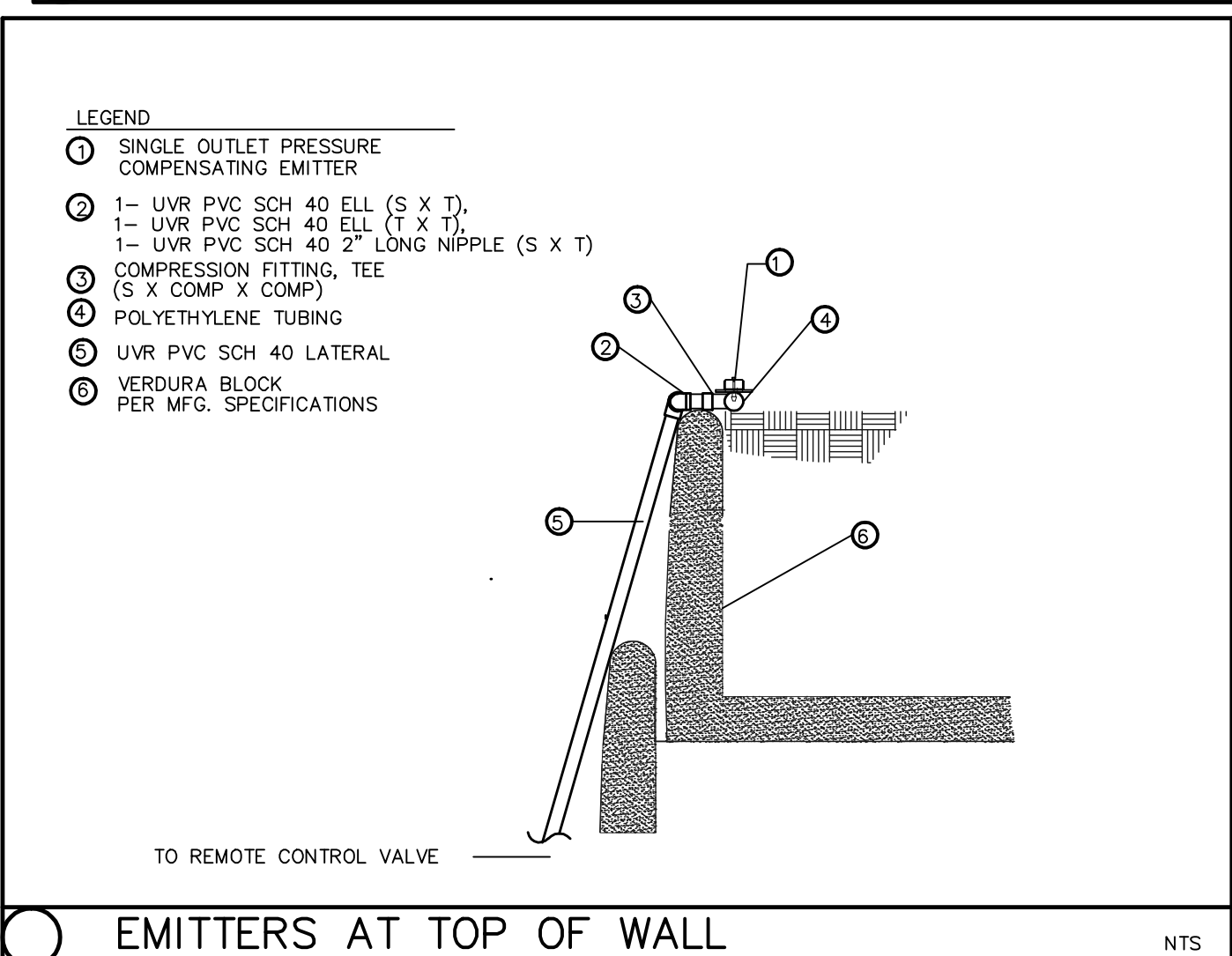
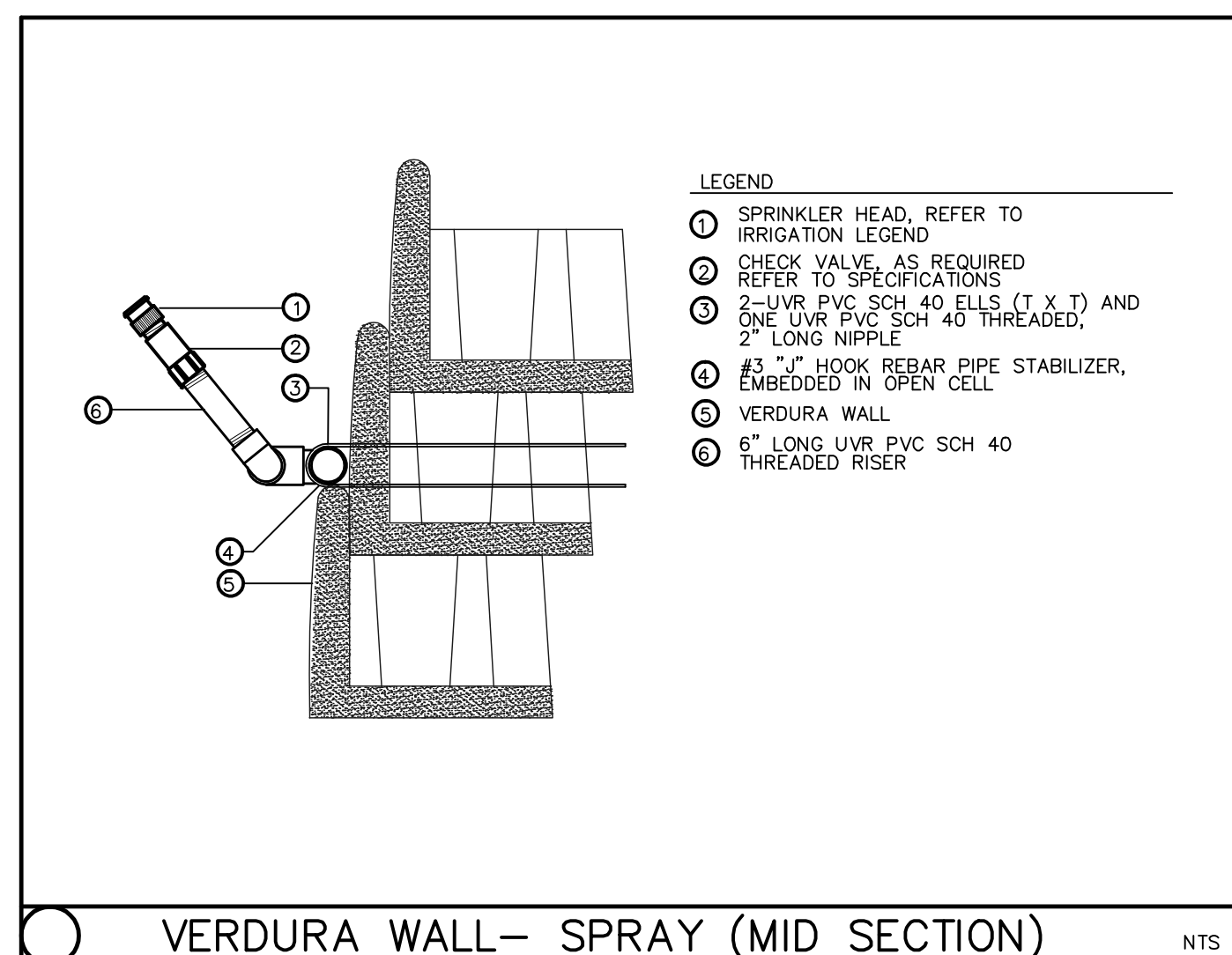
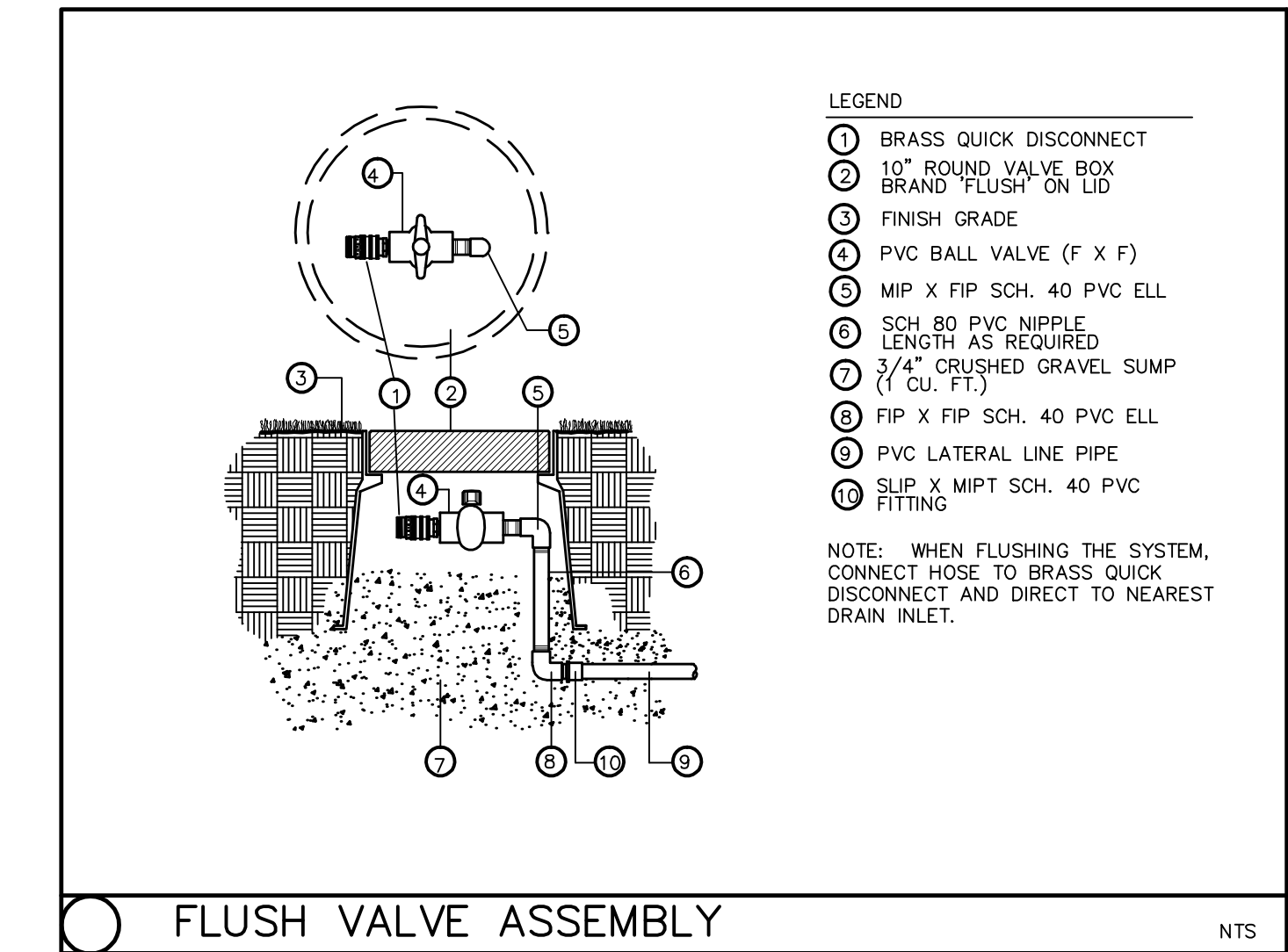
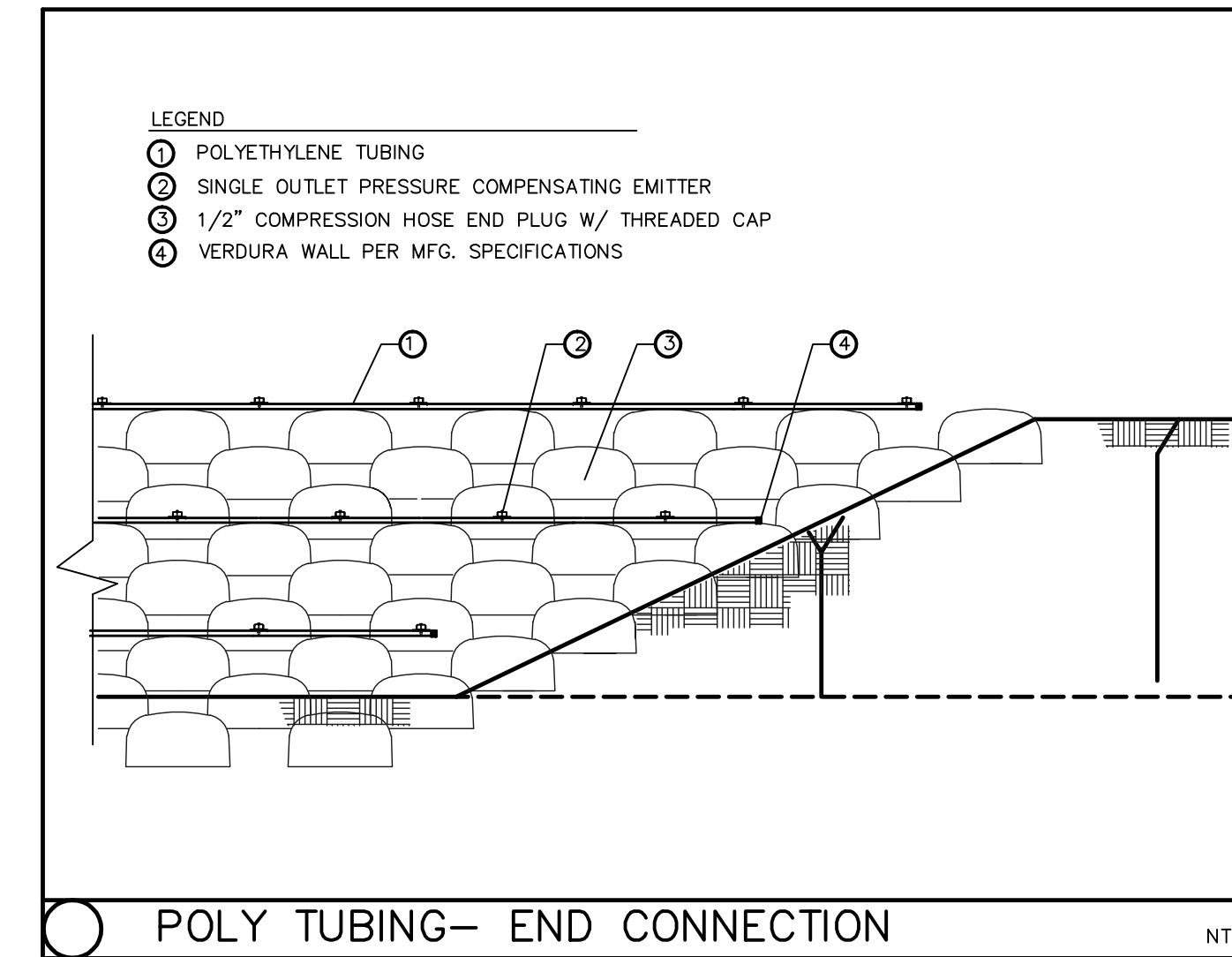
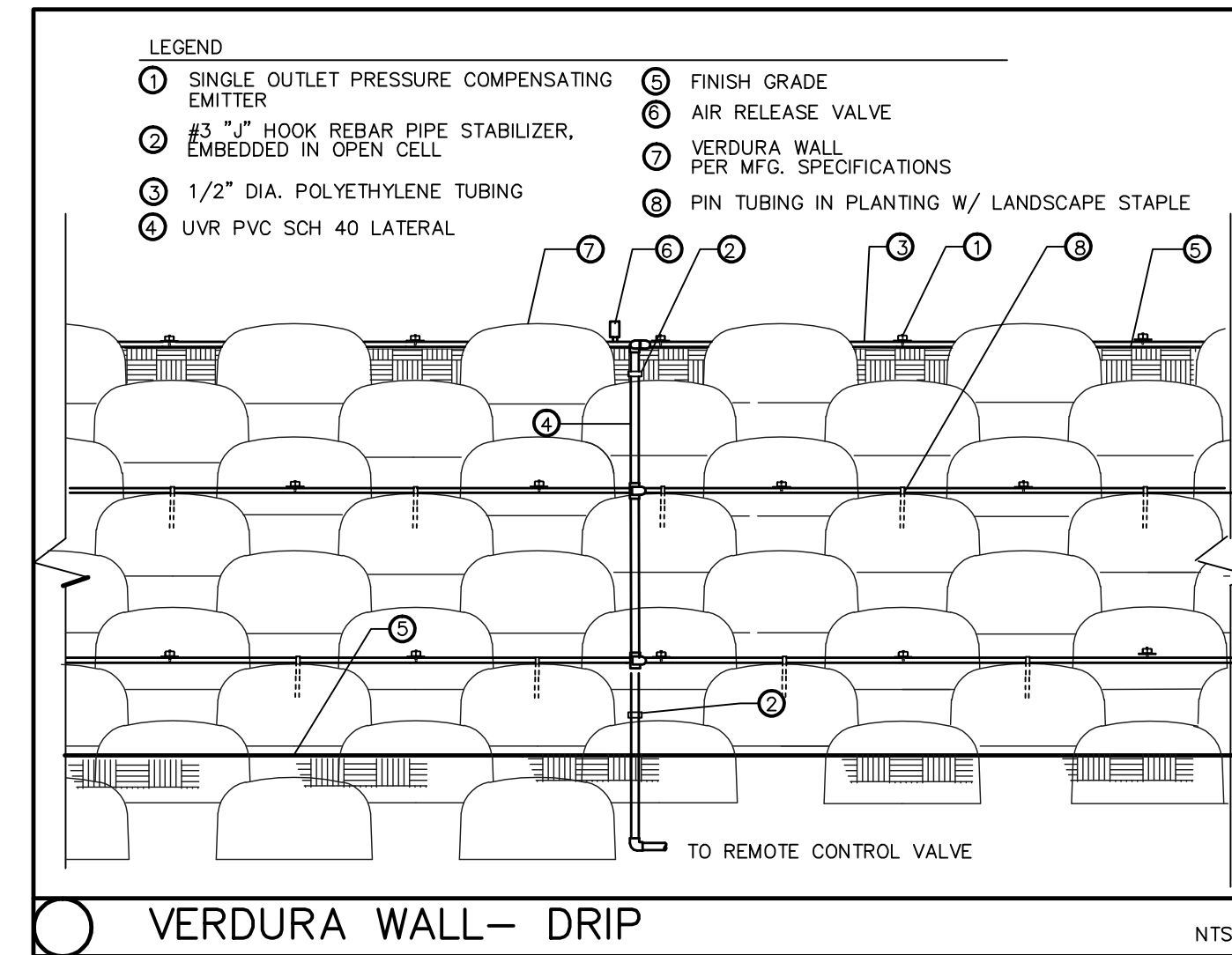
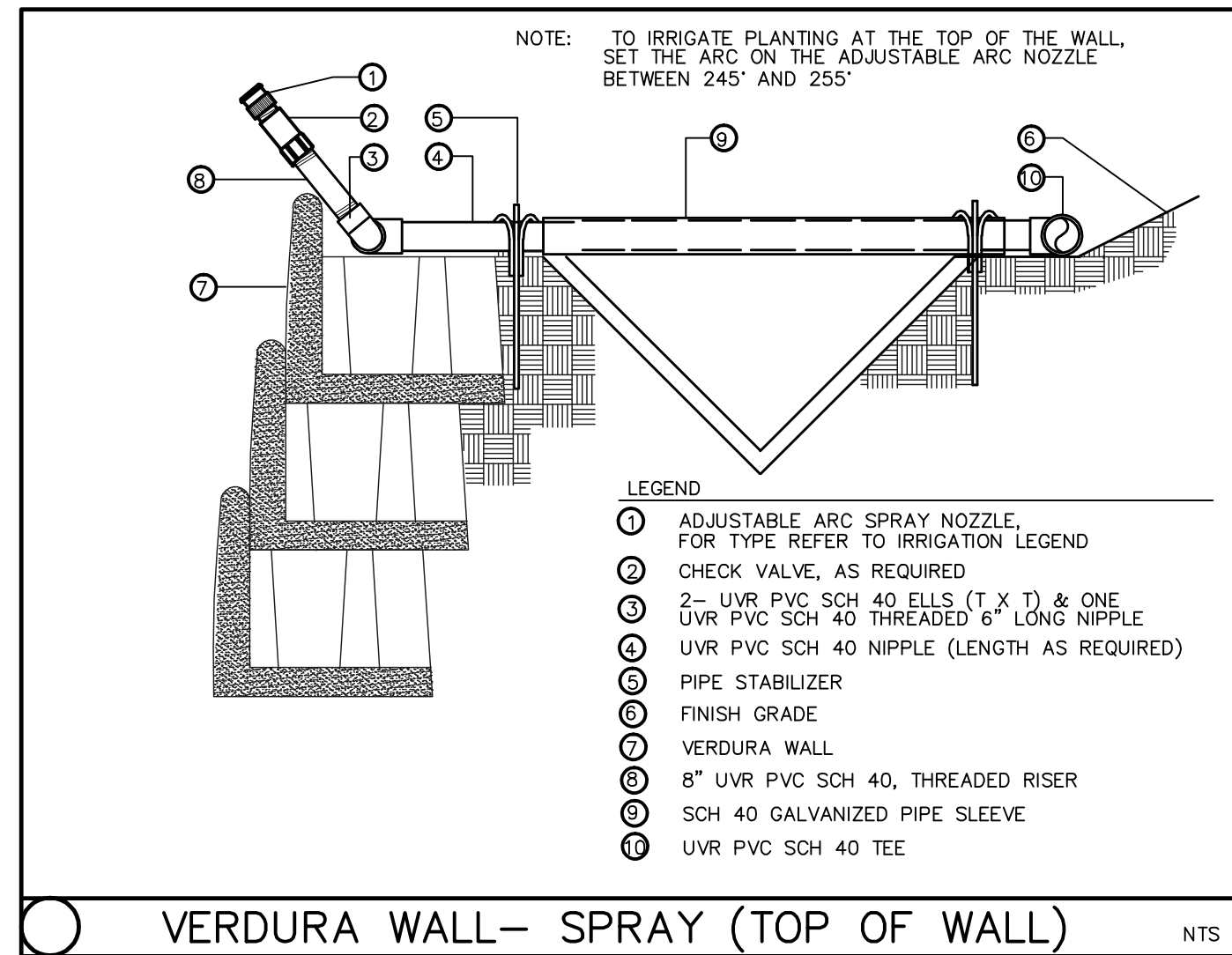

S:\SR2KSERVER\vol1\apps\SRdesign\CAD\IRRIGATION DETAILS\VERDURA-IRRIGATION DETAILS.dwg 04/12/11 11:05

NOTE:
WORK CONTAINED WITHIN THESE PLANS SHALL NOT COMMENCE UNTIL AN ENCROACHMENT PERMIT AND/OR GRADING PERMIT HAS BEEN ISSUED.

THE PRIVATE ENGINEER SIGNING THESE PLANS IS RESPONSIBLE FOR ASSURING THE ACCURACY AND ACCEPTABILITY OF THE STRUCTURAL DESIGN HEREON. IN THE EVENT OF DISCREPANCIES AFTER JURISDICTIONAL APPROVAL OR DURING CONSTRUCTION, THE PRIVATE ENGINEER SHALL BE RESPONSIBLE FOR DETERMINING AN ACCEPTABLE SOLUTION AND REVISIONS TO THE PLANS FOR APPROVAL BY THE COUNTY.

DATE	
COUNTY	

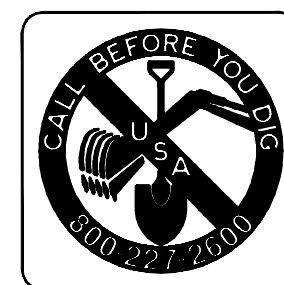

I HEREBY CERTIFY THAT THESE PLANS HAVE BEEN PREPARED UNDER MY SUPERVISION.

ENGINEER

DATE

SOIL RETENTION DESIGNS INC.
2501 STATE STREET, CARLSBAD, CA 92008 800-346-7995

REFERENCES

DATE:

DESIGNED BY:
DRAWN BY:
CHECKED BY:

VERDURA® SEGMENTAL WALL PLANS

XXXXX
XXXXX
XXXXX

IRRIGATION DETAILS

OF X SHETS.

FOR:

W.O.

COUNTY FILE NO.